



# Reducing CO<sub>2</sub> Slip from the Syngas Unit of an Ammonia Plant

Eddy Cooper

**Agrium Carseland Nitrogen Operations,**

*PO Box 5370, Station A, Calgary, Alberta, Canada T2H 2P4*

Ralph Weiland

**Optimized Gas Treating, Inc.,**

*12337 Jones Rd., Suite 432, Houston, TX 77070*

*The Agrium Carseland Nitrogen plant near Carseland, Alberta uses a promoted MDEA solvent to remove CO<sub>2</sub> from ammonia synthesis gas. The amine absorber in this unit was found to be operating unexpectedly close to its treating capacity limit, and treating performance was overly sensitive to production rate. A study was undertaken to determine the cause.*

*Pushing plant throughput had an exponentially deleterious effect on absorber performance. The relationship between CO<sub>2</sub> slip and production rate predicted by the ProTreat® mass transfer rate-based simulator was vastly different from plant measurements, indicating that performance was not what it should be. ProTreat also predicted a temperature bulge close to the base of the column. However, a thermal scan of the absorber showed the temperature bulge was actually much further up the column on the same side of the tower as the vapour inlet, and that it was relatively flat. The asymmetry of temperature is a good indication of flow maldistribution. The thermal scan indicated poor absorption performance across the bottom 5 metres of packing; whereas, absorption rates (and therefore temperatures) should have been highest there.*

*Channeling in the bottom of the absorber was identified to be the cause of the problem. One possible cause of channeling was the lack of liquid redistribution anywhere in the 13-m deep packed bed (a liquid redistributor at least every 6 metres is recommended at a minimum). Channeling was also detected via tower scans, and an analysis by Koch-Glitsch suggested a poorly designed inlet gas distributor as*

Paper to be presented at *Nitrogen + Syngas 2016*, 29 February to 3 March, 2016, Berlin, Germany

another possible cause. Besides resolving the operational problem, one of the most important learnings from this study was that, when used together, infrared temperature measurement, thermal imaging, and high quality tower simulation are a set of powerful, complimentary, diagnostic tools.

## INTRODUCTION

Most solvents used today for removing carbon dioxide from ammonia synthesis gas are based on *N*-methyldiethanolamine (MDEA) promoted with another amine that is highly reactive with CO<sub>2</sub>. Using MDEA as the main solvent ingredient permits greatly reduced energy consumption because MDEA does not react directly with carbon dioxide so the energy required to decompose amine carbamate does not have to be supplied. Lack of reaction with MDEA, however, precludes MDEA from being used alone as a solvent for deep CO<sub>2</sub> removal. Deep removal is achieved by using a relatively small concentration of a highly reactive amine such as piperazine. Piperazine reacts very quickly with CO<sub>2</sub> which greatly enhances absorption rates, and then the piperazine carbamate gradually decomposes and releases the CO<sub>2</sub> back into solution as bicarbonate. The hydrogen ion (acid) produced in the original piperazine reaction is mopped up by MDEA (base) which, therefore, really acts just as a sink for hydrogen ions:

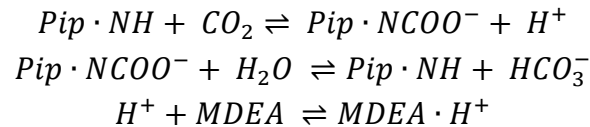

Piperazine is a very effective activator, although it is not the only one used commercially. Regardless of which promoter is employed, when using an *activated* MDEA solvent one is dealing with a highly reactive system in which a substantial amount of heat is released by the dissolution of CO<sub>2</sub> into the solvent, by its subsequent reaction with the reactive amine, and by the titration reaction of MDEA with released hydrogen ions. A substantial temperature bulge appears in the absorber, and reversing these reactions requires the supply of significant regeneration energy. The shape, size, and location of a temperature bulge are full of information and can tell an operator a lot about how an absorber is performing.

Unfortunately, absorption columns are rarely fitted with thermocouples *anywhere* along the height of the packed bed or on even a single tray within the set of trays held within the column. It will become evident as this story unfolds, that the provision of a few very inexpensive thermo wells can yield a wealth of diagnostic information that would be very useful for troubleshooting a malperforming tower as well as for routinely monitoring tower performance. Fortunately, there are other (albeit less convenient, although in some regards, more informative) ways of obtaining the same kind of information, namely thermal imaging, and mass transfer rate-based simulation. In fact, as will be shown, thermal scans and rate-based simulation are a formidable combination for troubleshooting both absorption and regeneration columns.

## BACKGROUND AND INCENTIVE

Agrium operates an ammonia facility near Carseland, about 40 km south east of Calgary, Alberta, Canada. The MDEA-based promoted amine system removes CO<sub>2</sub> from the process gas at the front end of the ammonia plant. Excess residual CO<sub>2</sub> (absorber slip) is poisonous to the ammonia converter catalyst so it is converted to methane (which consumes hydrogen) in the methanator prior to entering the ammonia

synthesis loop. This increases the inerts concentration in the gas and has the consequence of decreasing the ammonia production rate. Reducing CO<sub>2</sub> slip from the absorber by 1000 ppmv would result in increasing ammonia production by 8 MTPD. At a nominal margin of more than USD 200 per tonne, the monetary value is at least USD 600,000 per year for each 1,000 ppmv reduction in CO<sub>2</sub> leak.

Originally designed for operating with MEA, trays were replaced with random packing in the early 90s, and the plant was converted to a promoted MDEA solvent. In its current configuration, and under optimal operating conditions, with the CO<sub>2</sub> removal system operating properly and with all new catalyst, the plant is likely capable of producing about 1,600 MTPD of ammonia with a CO<sub>2</sub> slip of 300 ppmv. The plant has been debottlenecked several times so there is no “design” CO<sub>2</sub> slip or production rate—the objective is simply to achieve whatever is possible. Recently, the production rate has been measured at about 1,550 MTPD with a corresponding CO<sub>2</sub> slip of about 2,000 ppmv. Over time a large amount of production rate and corresponding CO<sub>2</sub> leak data have been collected. The data as summarised in Figure 1 show an exponential dependence of the CO<sub>2</sub> leak from the absorber on the production rate. Feedback from the solvent vendor and, as will be seen later, simulation results, indicate this behaviour should *not* be seen and is indicative of something probably being wrong with the absorber. A CO<sub>2</sub> slip below 500 ppmv should be achievable across the whole range of production rates shown in the plot. A carbon dioxide slip of 2,000+ ppmv translates into a production loss worth about one million USD per annum. Squeezing an additional 50 MTPD from the plant by running at 1,600 MTPD has an additional annual value in excess of 4 million USD. The total potential benefit is roughly 3.5% of gross revenue from the plant. The incentive to diagnose and correct the problem is quite substantial.

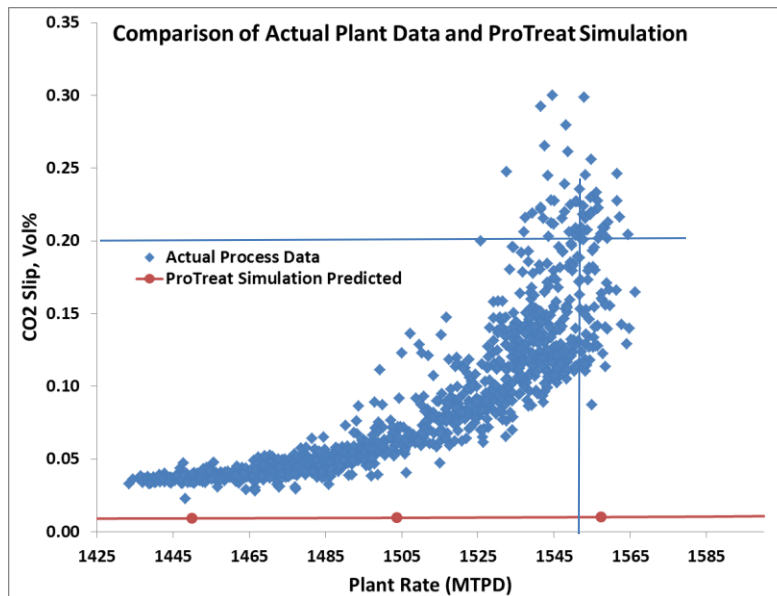

Figure 1 Measured Response of Absorber CO<sub>2</sub> Leak to Changing Production Rate

## THE CO<sub>2</sub> REMOVAL PROCESS AND ABSORBER PERFORMANCE

Figure 2 shows a simplified process flow diagram of the CO<sub>2</sub> removal unit. Our focus is on the absorber, so it will be sufficient to say that the solvent regeneration part of the unit appeared to be operating correctly at all times, and always produced a lean solvent typical for a promoted MDEA system. The molar lean solvent loading in this case is generally in the range 0.020 to 0.025 moles CO<sub>2</sub> per mole of total amine in the solvent. Simulation work was always carried out on the whole absorber/regenerator system, and the results presented here pertain to this full-unit simulation.

The absorption column (Figure 3) is 11-ft diameter with 42 feet of a random packing: it is connected into the rest of the system as shown in Figure 2. The top of the absorber contains a short section of structured packing in which the gas is contacted with a small wash water flow to recover amine vapour and reduce vapourisation losses. Operating pressure is typical for ammonia synthesis, 2,560 kPa. Raw gas is 3:1 H<sub>2</sub>:N<sub>2</sub> with small amounts of argon, methane, and helium, flowing at the typical rate of 146,000 kg/h (185 MMscfd). The syngas is treated with 240 L/s (3,800 USgpm) of nominally 50 wt% of an activated MDEA solvent.

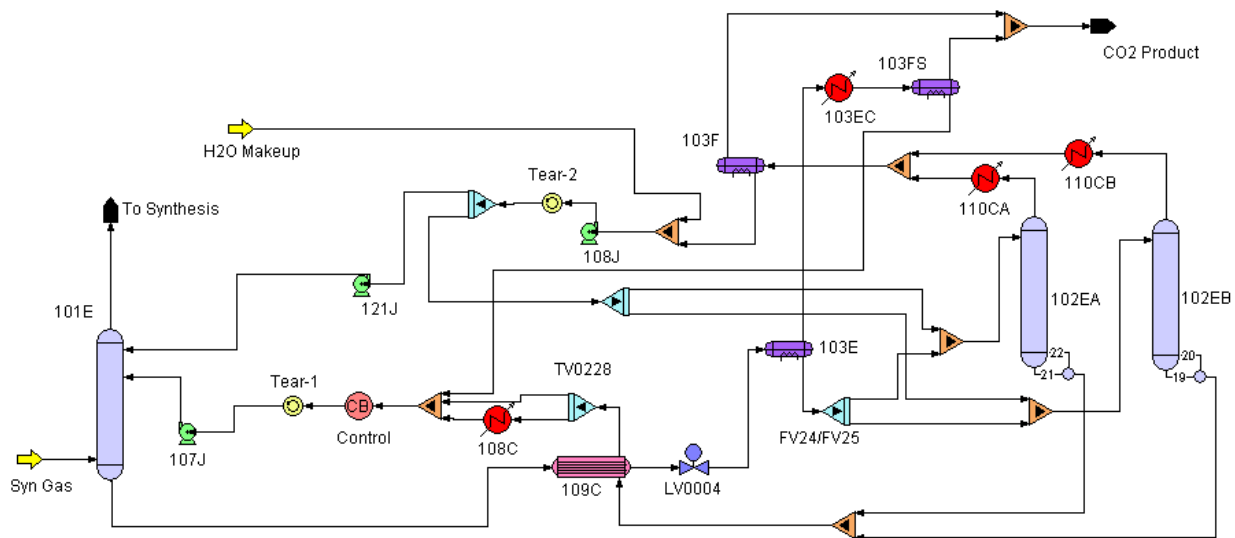

Figure 2 Schematic of CO<sub>2</sub> Removal Unit

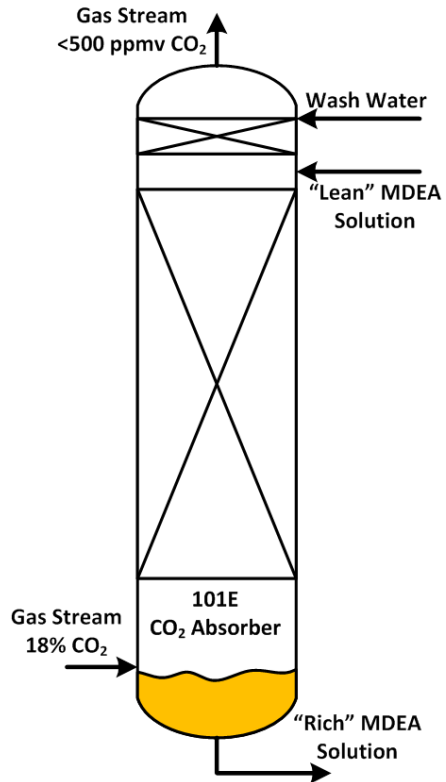
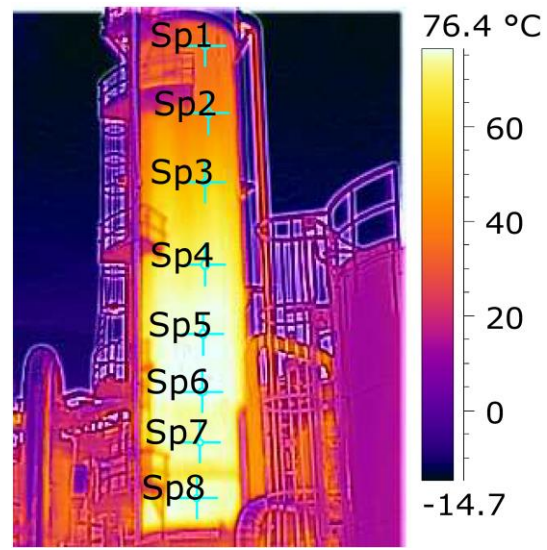
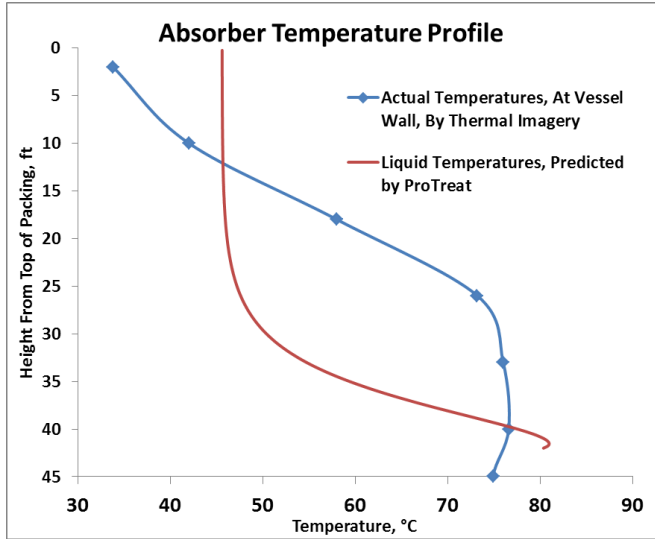

Figure 3 CO<sub>2</sub> Absorber

## DIAGNOSIS

Information from the solvent supplier was that the exponential behaviour shown in Figure 1 should not be occurring in the range of production rates shown in this plot. Treated gas should easily be  $< 500$  ppmv CO<sub>2</sub> everywhere in the range to 1,600 MTPD. Modeling using the ProTreat® mass transfer rate based simulator showed the treated gas should contain about 190 ppmv CO<sub>2</sub> at all production rates. This was certainly at odds with observation. ProTreat provides a prediction of temperature and composition profiles (and other data, too, including component flows, properties, and hydraulic data) in both phases at every point along the height of the absorber. Figure 4(a) compares the predicted temperature profile with the profile extracted from thermal imaging of the bare tower shell. Figure 4(b) shows the thermal scan, taken with a FLIR T-series thermal camera.

Simulation predicts that the bulk of the absorption takes place very close to the bottom of the absorption bed so one should expect to see temperature peak quite sharply there. The absorption rate, as implied by the temperature profile, falls to nearly zero as the top of the bed is approached. Simulated CO<sub>2</sub> concentration profiles bear this out. The thermal image shown in Figure 4(b) was taken on the side of the absorber containing the gas inlet nozzle. It indicates most of the absorption has already taken place in the top 25 ft. or so of the bed, and the bottom 16 ft. are doing nothing — there is no temperature change so there is no absorption there either. If the column's bottom 16 ft. is essentially inactive, the 42-ft bed will perform more like a 26-ft bed. Performance will suffer, and that's completely in line with what was being experienced. The question, then, is why the measured temperature profile is at such odds with simulation.



(a) Simulated and Measured Temperatures

(b) Thermal Image on Gas Inlet Side

Figure 4

Temperature Profiles and Thermal Image

## THERMAL IMAGES AND THEIR INTERPRETATION

The bare, uninsulated absorber was photographed with an infrared camera from the three angles shown in Figure 5. The feed gas nozzle is on the northeast side of the tower. These orientations are what were permitted by the proximity of other equipment in the vicinity. As shown in Figure 6, the thermal images are quite revealing.

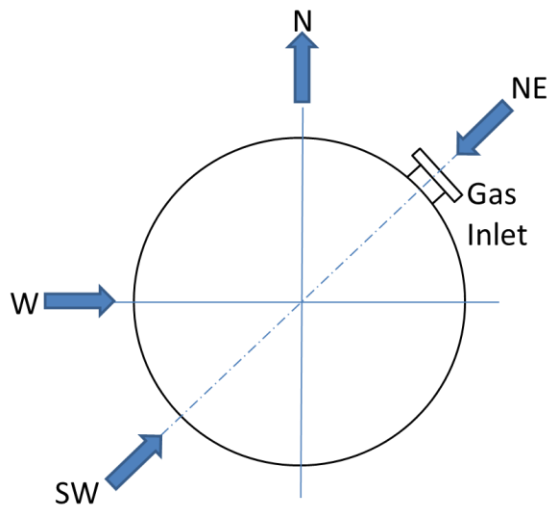

Figure 5 Orientations of Thermal Imaging Camera

Referring to Figure 6(a) the shell on the gas inlet nozzle side of the tower is extremely hot (76°C, or 170°F) over almost the entire lower half, which is in strong disagreement with the simulation. But when the side of the tower opposite the gas inlet is examined (Figure 6b) the shell is quite cold (32°C, or 90°F) over the whole height of the tower. Figure 6(c) is a view that encompasses part of both sides of the shell seen in Figures 6(a) and (b). Although the physical layout of the unit allows an image of only the top half of the column to be recorded, it corroborates the above observations by showing high temperatures on the gas inlet side and uniformly cold conditions on the opposite side.

A tower that is operating properly with good liquid distribution over its entire height will not show very much temperature variation around its circumference at any given elevation. This column shows extreme variation. The side of the column opposite the inlet nozzle appears not to be processing much gas because the liquid simply flows down the height of the packing in this cross-section with much the same temperature as it had on entering the column. Obviously the solvent there is not contacting much gas, or at least is not absorbing much CO<sub>2</sub>, because there is a large liquid flow contacting a small gas flow (high L/V ratio). This results in a small temperature rise because of small total absorption. On the nozzle side, conditions are extremely hot. Here there is a lot of absorption occurring, and high temperatures can occur only if a lot of CO<sub>2</sub> is being absorbed by a small solvent flow (low L/V ratio) because this will heat the solvent to quite high temperatures.

Discussion with the tower internals supplier resulted in the suggestion that some mechanical means must be provided to ensure *even gas distribution*. This is especially the case with large diameter towers (this absorber is 3.3-m or 11-ft diameter) handling a very high vapour rate. In this case, the gas velocity from the inlet nozzle is about 20 m/s (65 ft/s) which is very unlikely to change into a uniform upwards flow of 0.1 m/s (0.3 ft/s), its superficial velocity through the tower, without mechanical assistance. A Schoepentoeter is a commonly-used, mechanical, vane device well suited to this purpose. A possible factor contributing to hydraulic and, therefore, mass transfer malperformance is lack of liquid redistribution part way down the column. As a general rule packing suppliers recommend liquid redistribution at least every 5.5 – 6 m (18 – 20 feet).

Simulation using the ProTreat® mass transfer rate based tool shows that a production rate of 1,600 MTPD with less than 300 ppmv CO<sub>2</sub> slip can be achieved easily in a correctly running absorber. The value of making physical changes to ensure proper vapor/liquid contact is significant, and it must be carefully compared to the cost of the plant downtime required to make those changes. In this situation the changes have maximum economic benefit only when done as part of a planned turnaround.

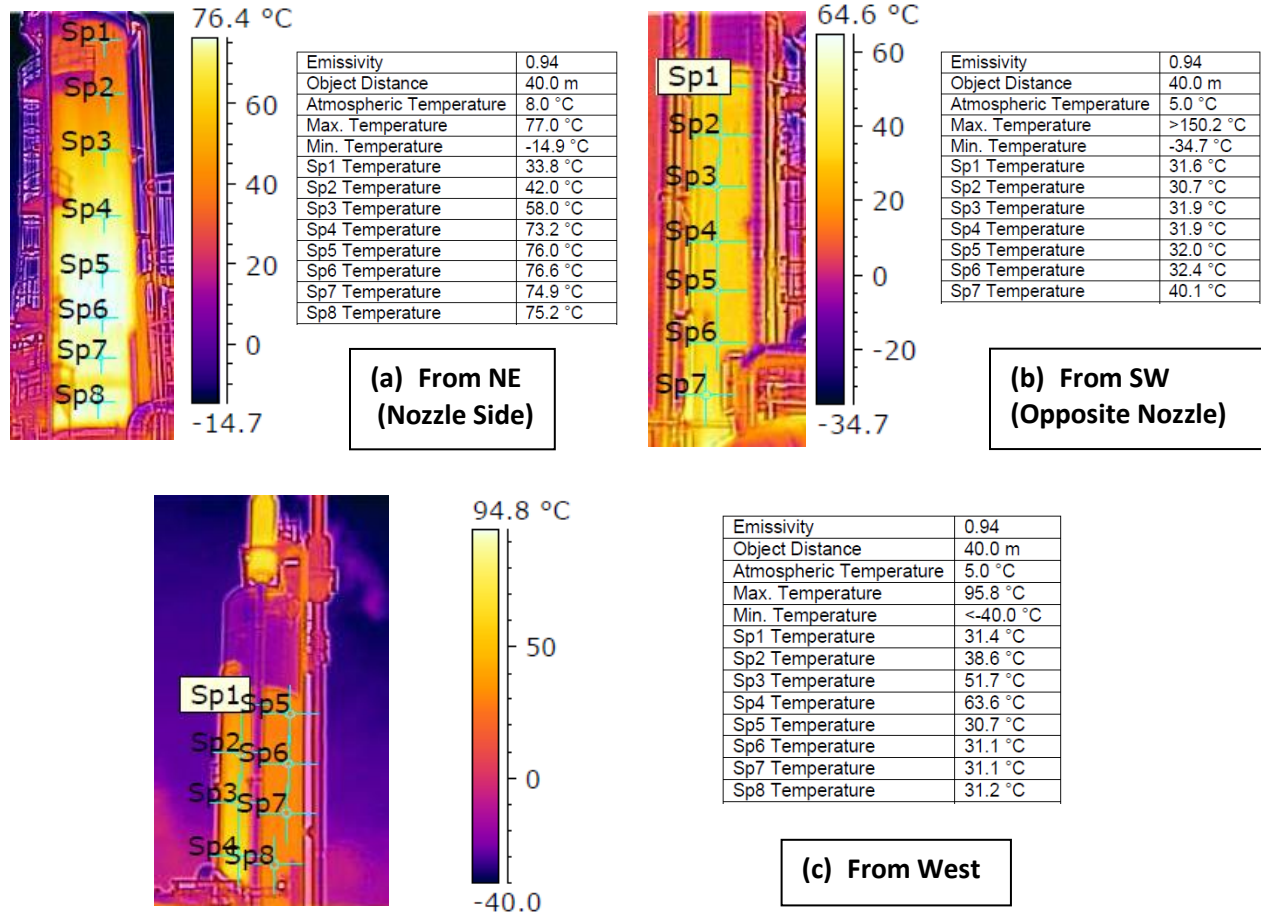

Figure 6 Thermography Images Taken from Three Directions

## OPTIMIZING OPERATING CONDITIONS

Before looking at possible physical problems with the absorber, an experimental method was used to ensure that the operating conditions were optimal. As discussed previously, the focus of the work was confined to the absorption tower. Lab testing had showed that the lean loading was in an acceptable range, and there was no reason to suspect the solvent chemistry. Three easily-changed variables were selected for experimentation: (1) solvent inlet temperature, (2) absorber liquid level, and (3) solvent flowrate. The following list shows the variables considered, and the reasoning for selection.

- Solvent inlet temperature (inferred indirectly via the absorber bottom temperature) – selected due to its theoretically significant effect on removal performance
- Absorber liquid level—selected because of anecdotal evidence that it had an effect, possibly from the level being above or below the vapor inlet distributor pipe
- Solvent flowrate —selected because of its theoretical effect on removal performance
- Solvent concentration—rejected because a short timeframe for experimentation was needed (concentration changes take days), and historical data suggesting that it is not a problem



- Gas inlet temperature—rejected because of minimal theoretical effect on removal performance (the vapor heat capacity in this absorber is insignificant compared to the liquid heat capacity)

The experiment was designed using Minitab 16 software. With three variables, a multi-variable testing approach was used, with all three variables being changed simultaneously. This type of experimentation is vastly superior to a simple one-variable-at-a-time testing approach, which can completely miss interactive behaviour in non-linear systems such as this one.

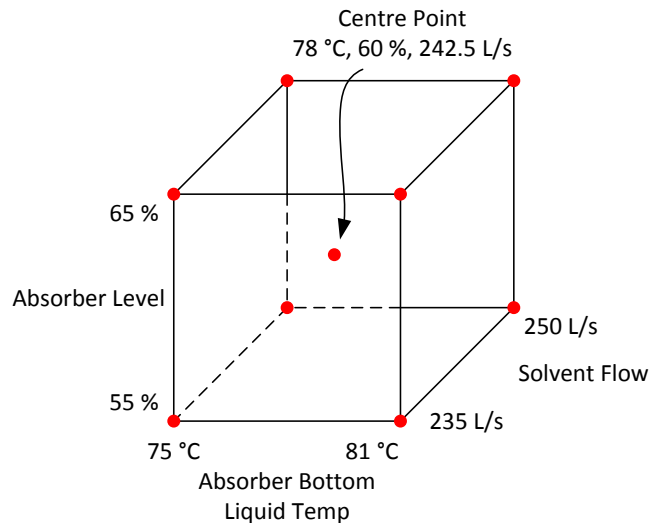

**Figure 6 Visual Representation of Process Experimentation**

Figure 6 shows the experimental setup in a visual format. The actual values were selected based on existing normal operating conditions, the capabilities of the physical equipment, and the comfort level of the operators running the test. Each of the corner points was tested twice and the centre point was tested three times, for a total of 19 steps. The run order was randomised.

The experimentation took place over a single day when the plant was relatively stable. Between each of the 19 runs, a minimum of 30 minutes of settle-out time was specified (a complete cycle of solvent through this system is approximately 13 minutes and the residence time in the absorber is much shorter than this). The details of the data analysis will not be explored here, but it was in accordance with Minitab's suggested methodology.

The results showed that the original operating conditions were already optimal, at least at the conditions seen during testing.

- Absorber sump liquid level had no significant effect on CO<sub>2</sub> removal. However the level reading did become unstable near the point where the liquid level covered the vapour inlet distributor.
- Solvent flow had some effect – higher flow produced better CO<sub>2</sub> removal, but the range used in this experiment was small and, therefore, the actual effect on performance was not as conclusive as it could have been.

- Solvent inlet temperature had a significant effect. Over the range of testing done here, an optimal point existed somewhere near the centre point. This shows that the system is non-linear, which was also indicated by ProTreat® simulations.

All deviations from the original operating conditions decreased CO<sub>2</sub> removal performance (i.e., increased CO<sub>2</sub> slip). Thus, the conclusion drawn was that the operating conditions were not the cause of poor absorption performance, and the investigation moved to a physical troubleshooting exercise that included thermal and radiographic inspection techniques.

It should be noted that the same type of analysis can be done using ProTreat simulation results. Multi-variable testing using numerous simulation cases can find theoretically-optimal operating conditions. Using ProTreat together with this type of analysis can produce excellent starting points for choosing real-world operating conditions. From those starting points, the system then can be fine-tuned through real-world testing as was done here.

## **CONCLUDING REMARKS**

The economic incentive for performing a thorough and thoughtful analysis of absorber performance was quite significant, and multivariate experimentation was very effective in reducing the total time needed for experimentation. The coupling of thermal images taken from various directions with the use of the ProTreat® mass transfer rate-based simulator was a powerful combination that allowed the cause of the malperformance to be successfully diagnosed. In particular, simulation showed what the temperature profile *should* look like, and when compared with measured profiles, it became persuasively clear that there was very likely a gas, and possibly a liquid, maldistribution problem in the packed bed. The study showed that high quality simulation is an inexpensive tool that can pay for itself in less than a single day.